

Digital

Partner

Mediendienstleistungen

Das DIY modulare Display-System



Do-it-yourself | unbegrenzte Flexibilität | kostengünstig

Digital Partner ist Vertriebspartner der Luban-Display-Company

Die Komplettlösung für Messen oder Events

Wir bieten die Komplettlösung für Messen und Events inklusive Grafiken, Regale, Produktdisplays, Ablagen, Theken, Lagermöglichkeiten, Kabinen, Multimedia, Beleuchtung und Transportverpackungen





Do-it-yourself

Schieben und Klicken - so einfach



Die Aluminium-Profile werden als Rahmen zusammen geschoben und mit dem speziellen Klickmechanismus arretiert - alles werkzeuglos!

Nur wenige montagefertige Komponenten

Leicht und werkzeuglos aufzubauen, kleines Transportvolumen, geringes Gewicht, wenig Lagerfläche

Standard-Grundstruktur

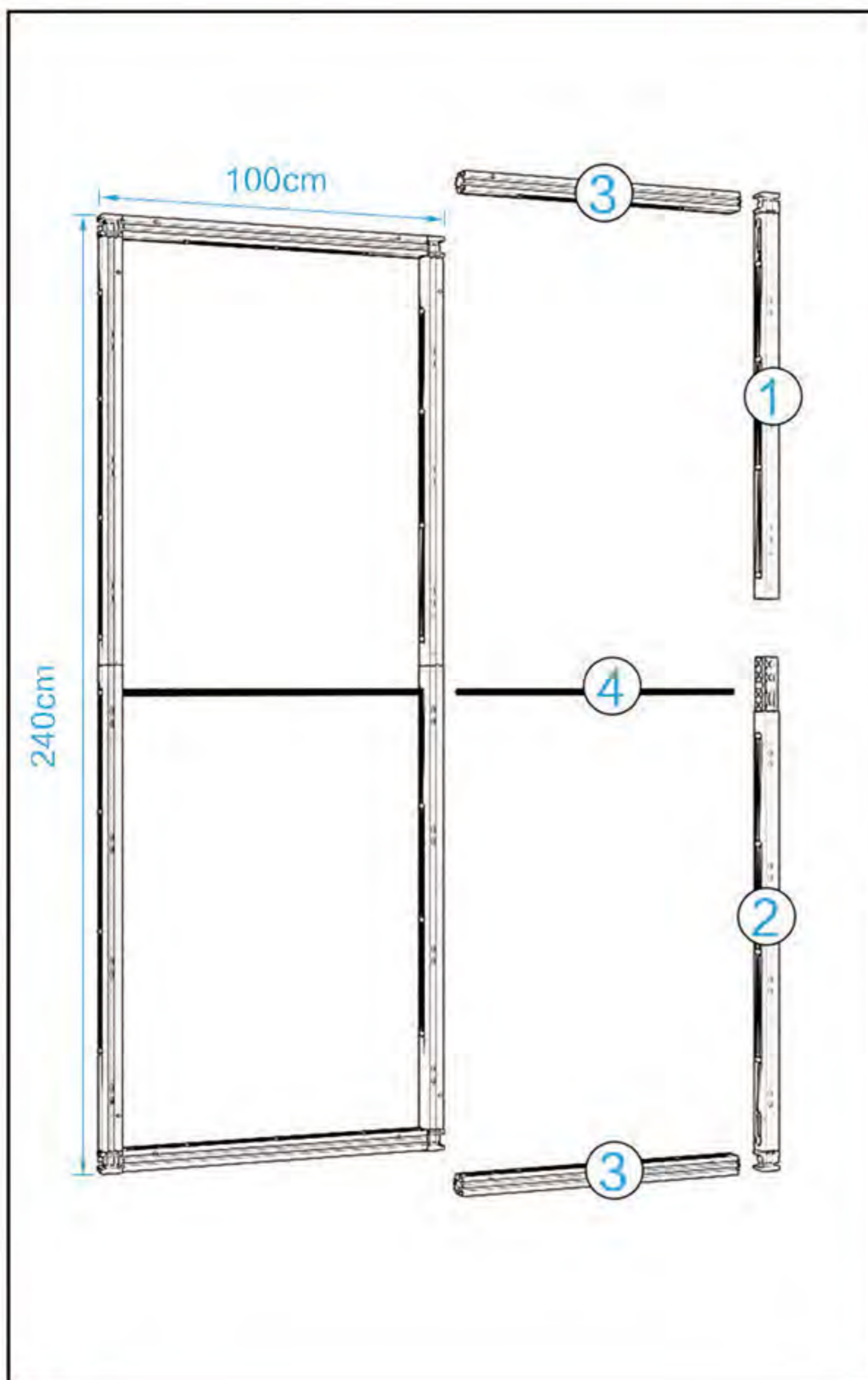

Vertikale Stange oben

Vertikale Stange unten

Horizontale Stange



Mittelstange



Zubehör

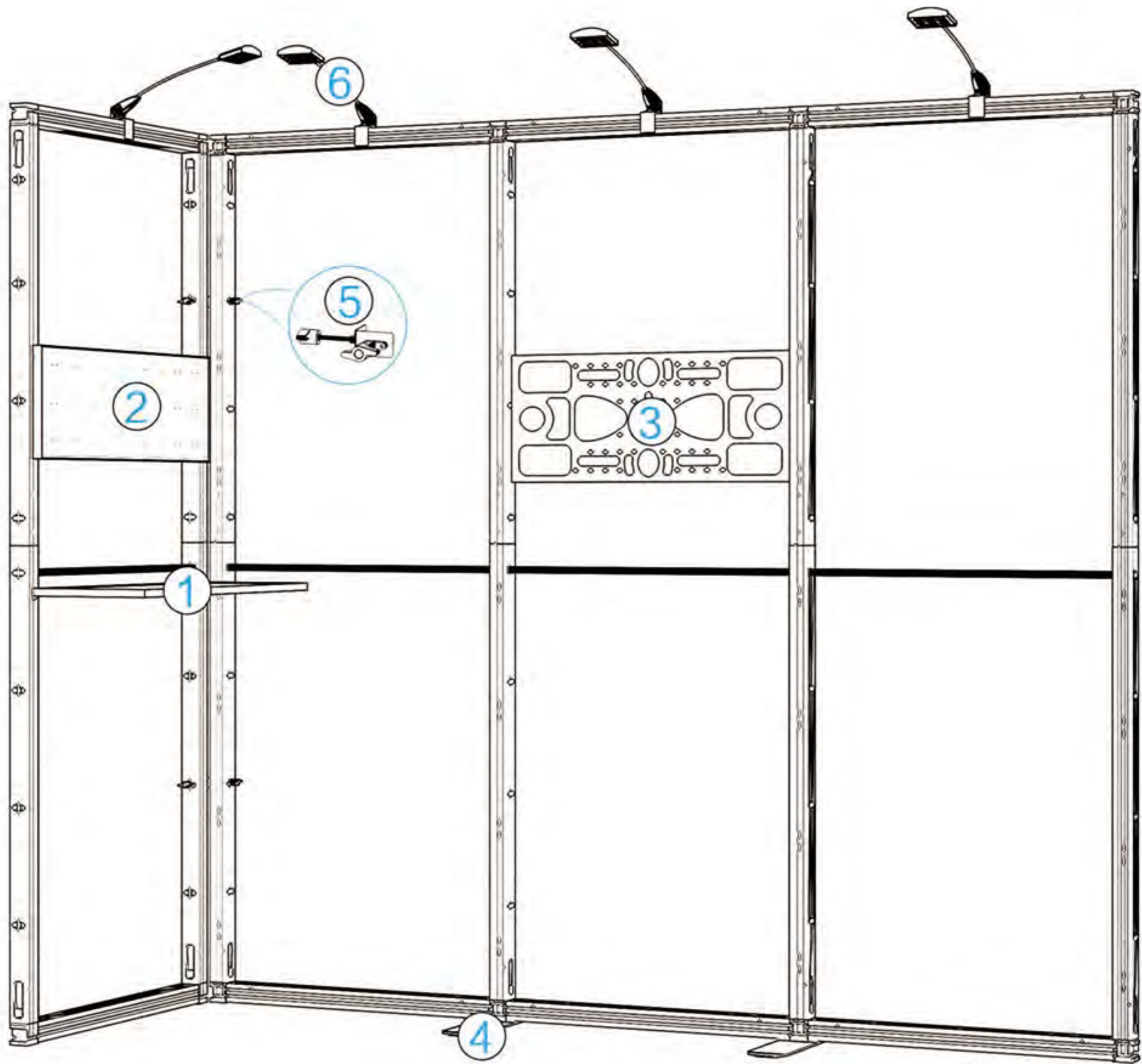

Regale

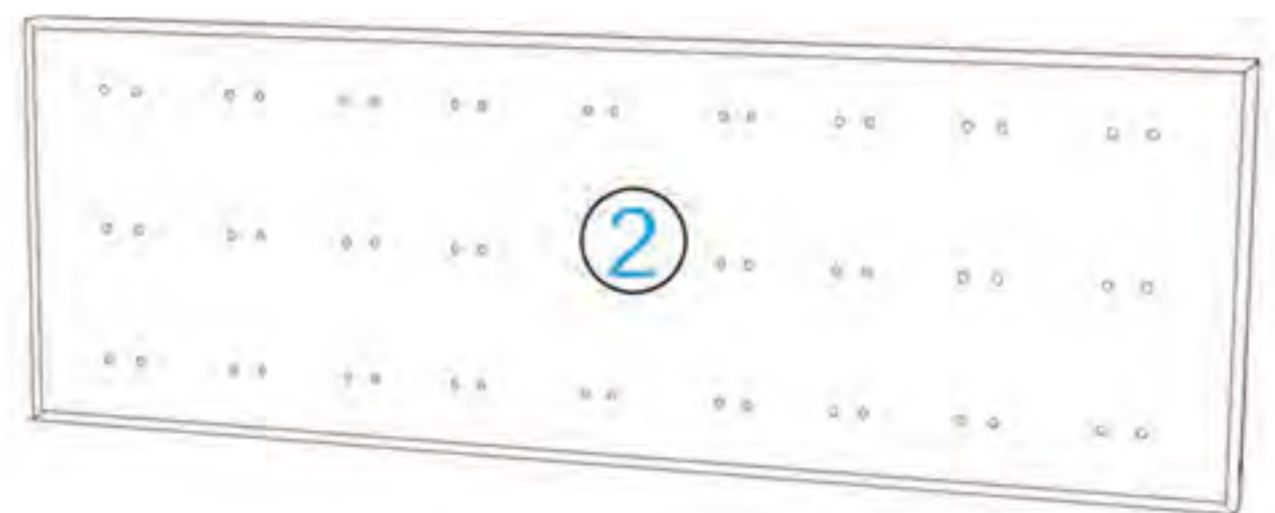

Produkt-Displays

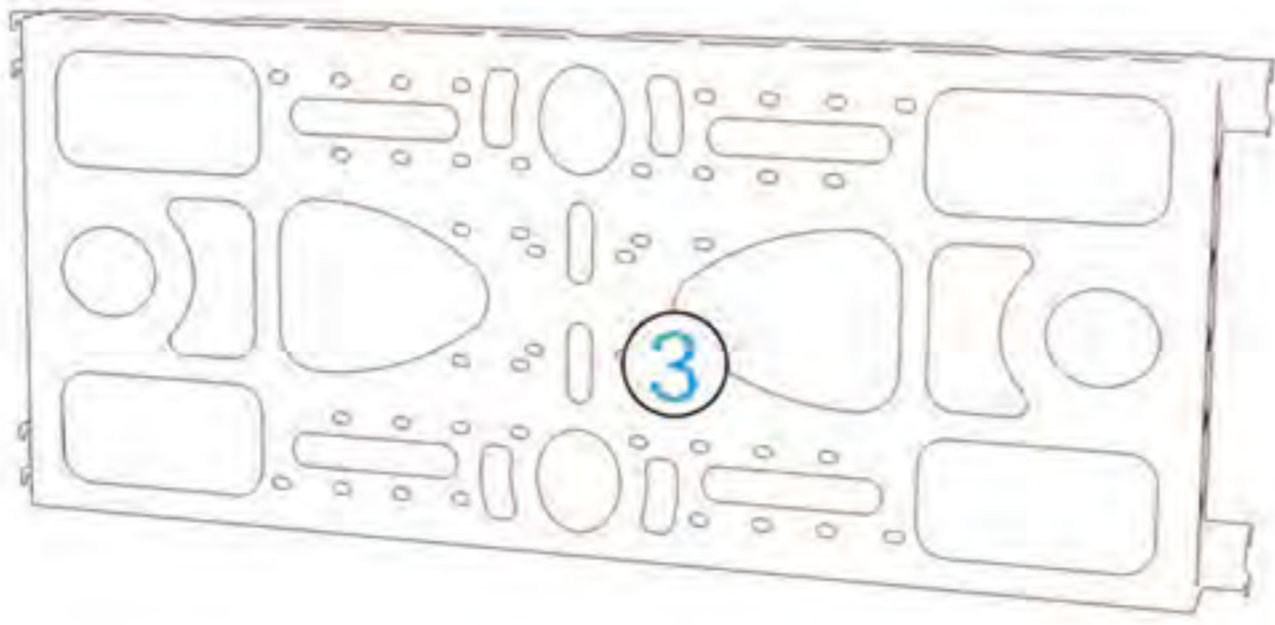

Bildschirmhalterung

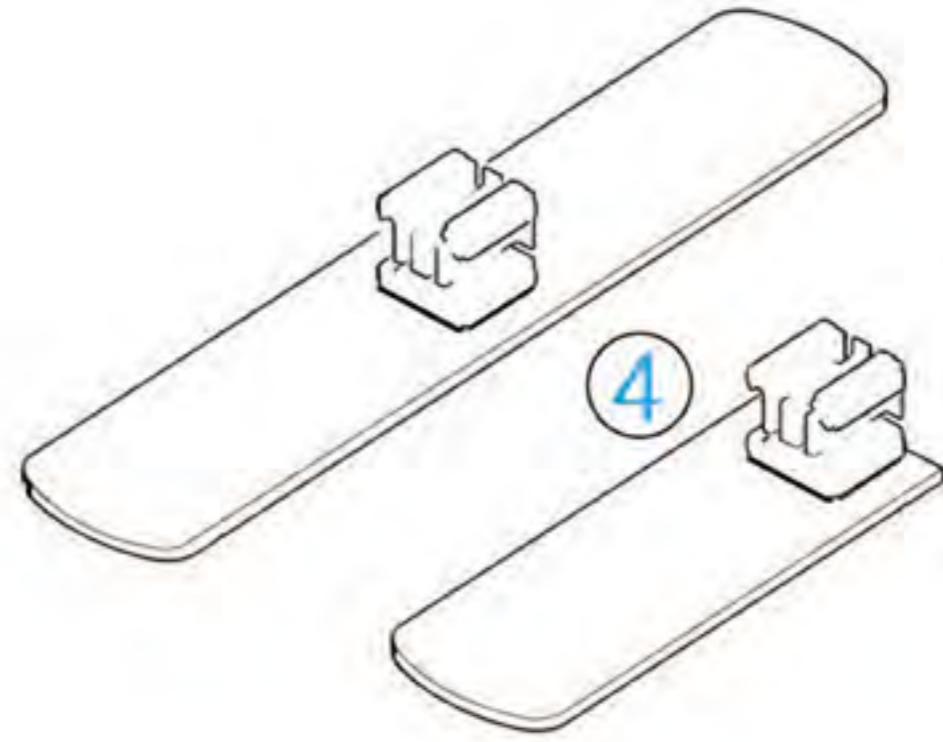

Fuß ganz/halb

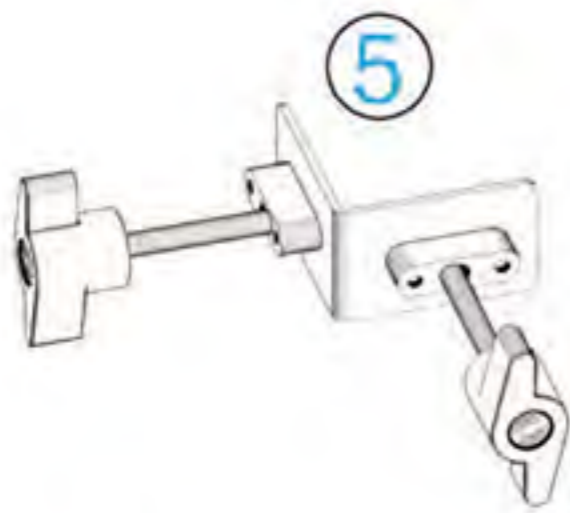

Eckverbindung



LED-Lichthalterungen

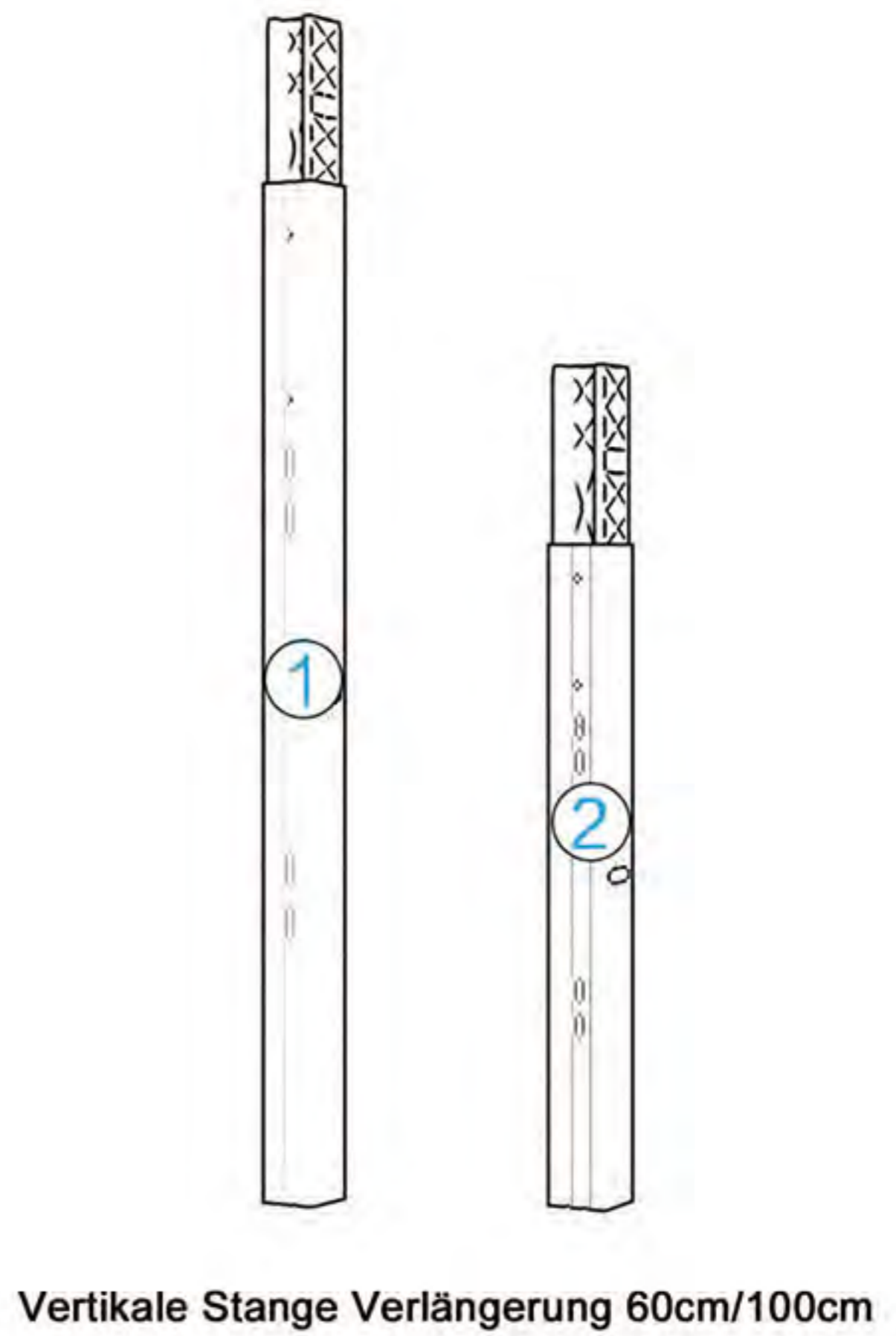
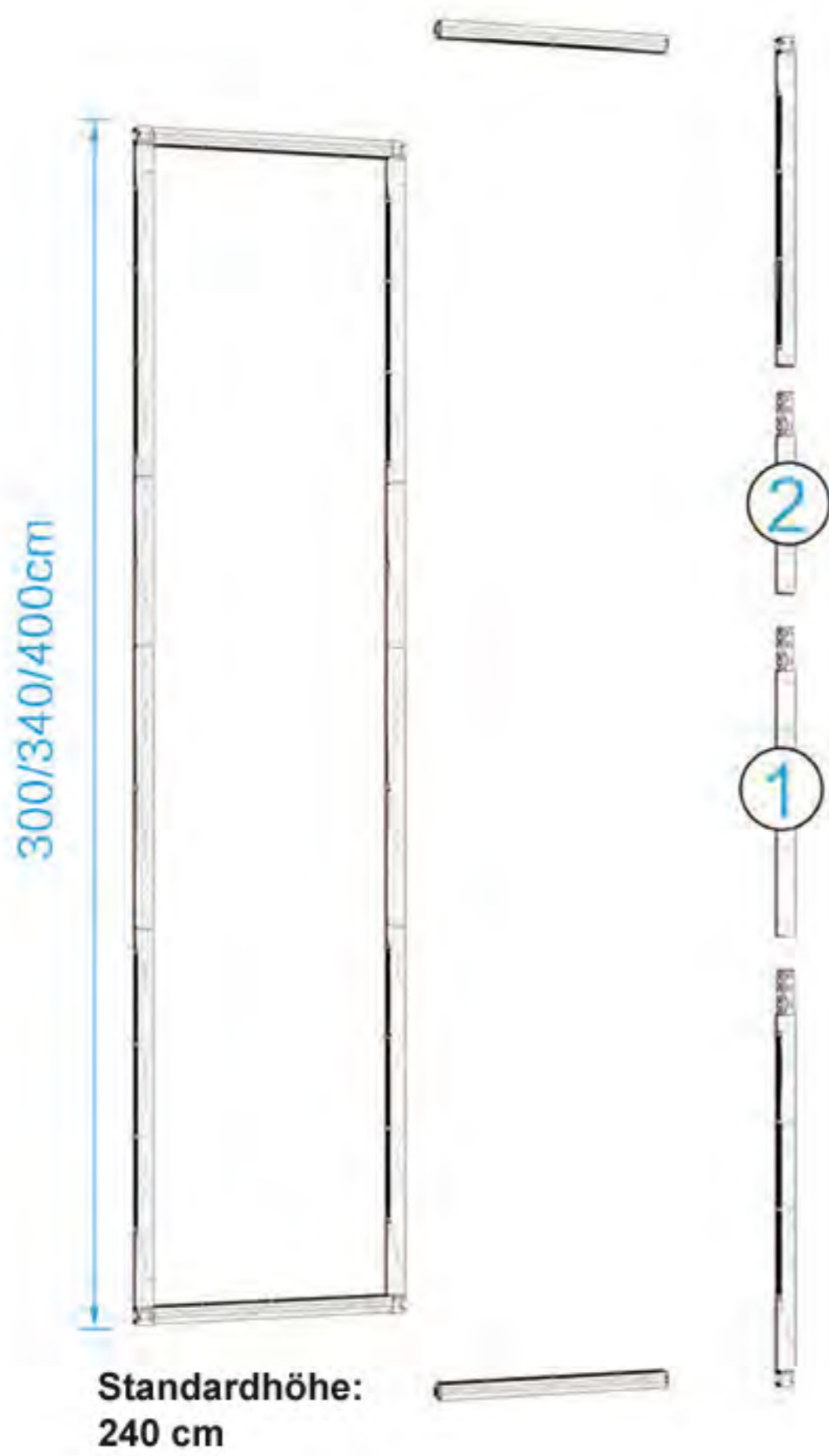

Perfekt für Textil-Grafiken



Ein Silikonstreifen wird mit der Textilgrafik vernäht.

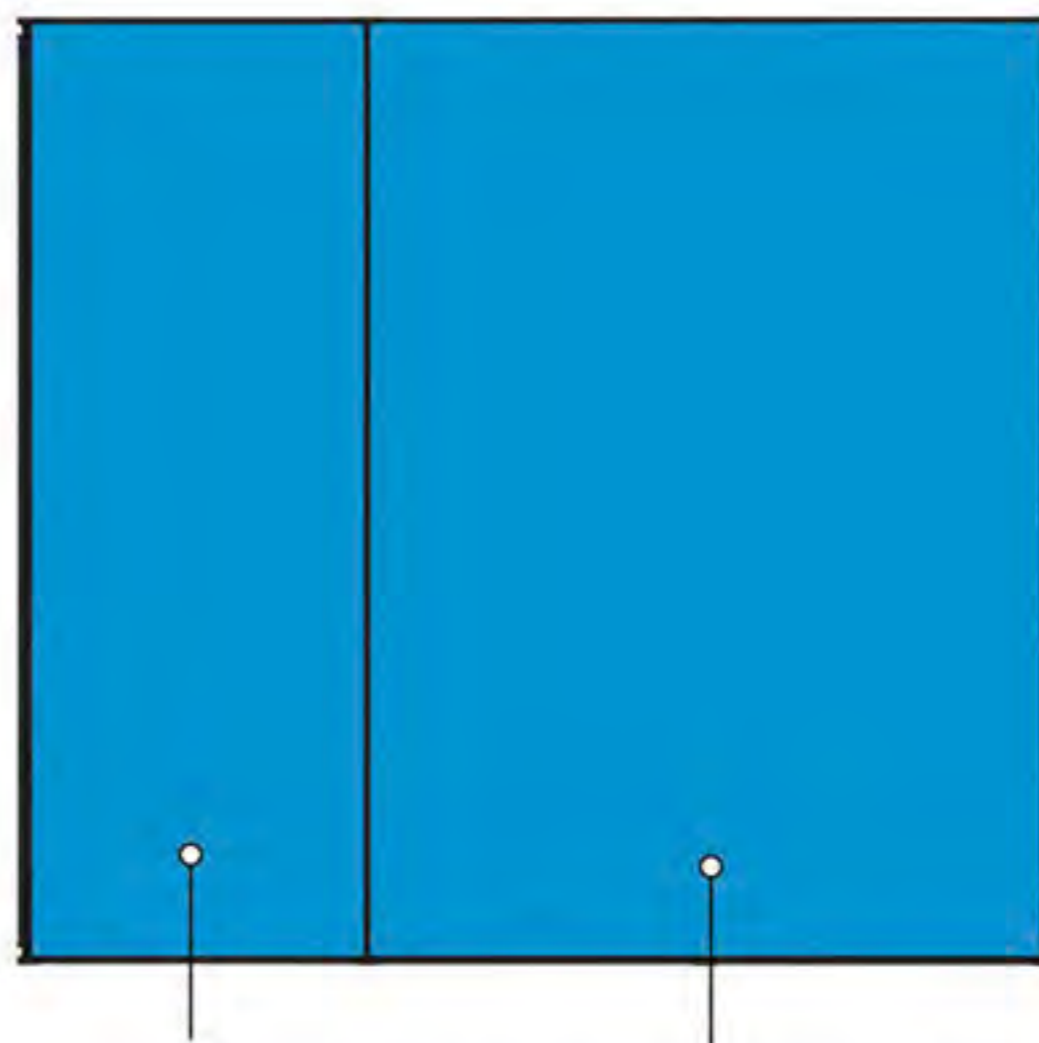

Druck eines Abschnitts Nahtloser Druck über mehrere Abschnitte

Transportverpackungen



Flight-case

70 Stangen (ca. ein 15mx2,4m Set) passen in eine Flight-case



Transportkoffer

8 Stangen passen in einen Transportkoffer (ein ca. 3mx2,4m Stand in 2 Transportkoffer)

Das ideale Startpaket

Eine Flight-case für unendlich viele Anwendungen



Artikel	Menge
Vertikale Stange oben	18
Vertikale Stange unten	18
Horizontale Stange	28
Mittelstange	14
Fuß ganz	6
Fuß halb	4
Eckverbindung	12
Regalset (2x)	4
Produkt-Display (2x)	2
Bildschirmhalterung	1
Haken	8
Crystal LED-Licht	12
LED-Lichthalterung	12
Flight-case	1

Referenzdesigns

Beispiele 6m

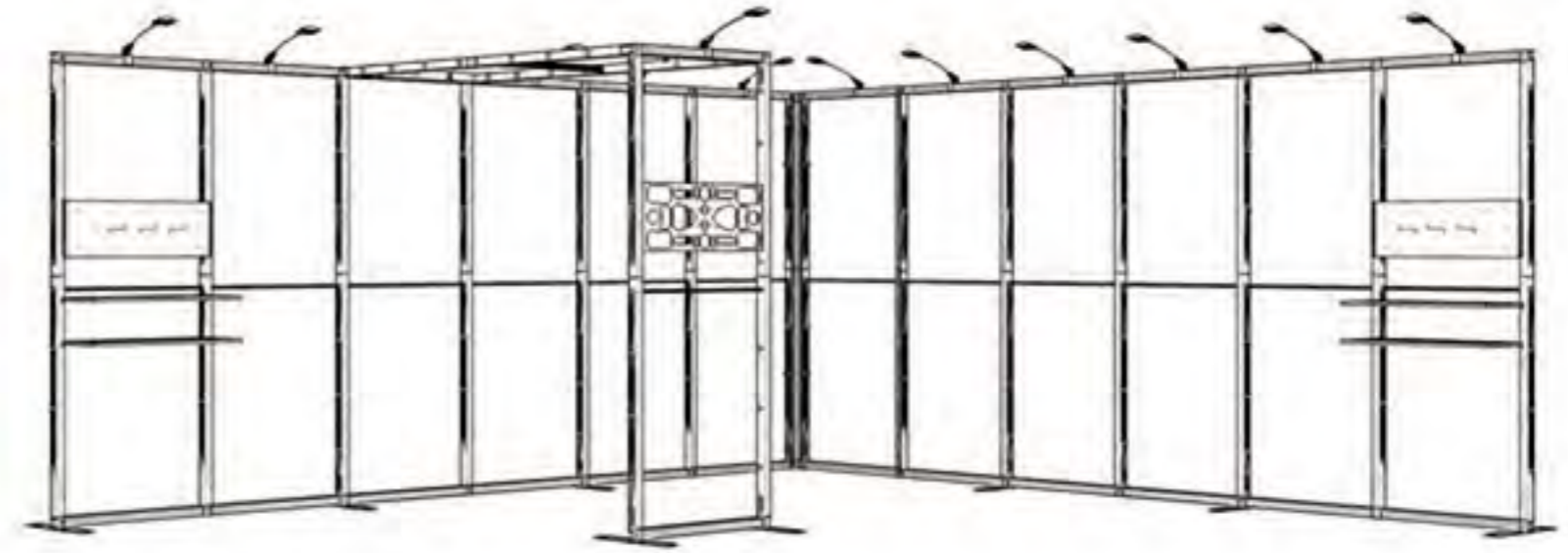

Luban kit 6m/20'
NO.001

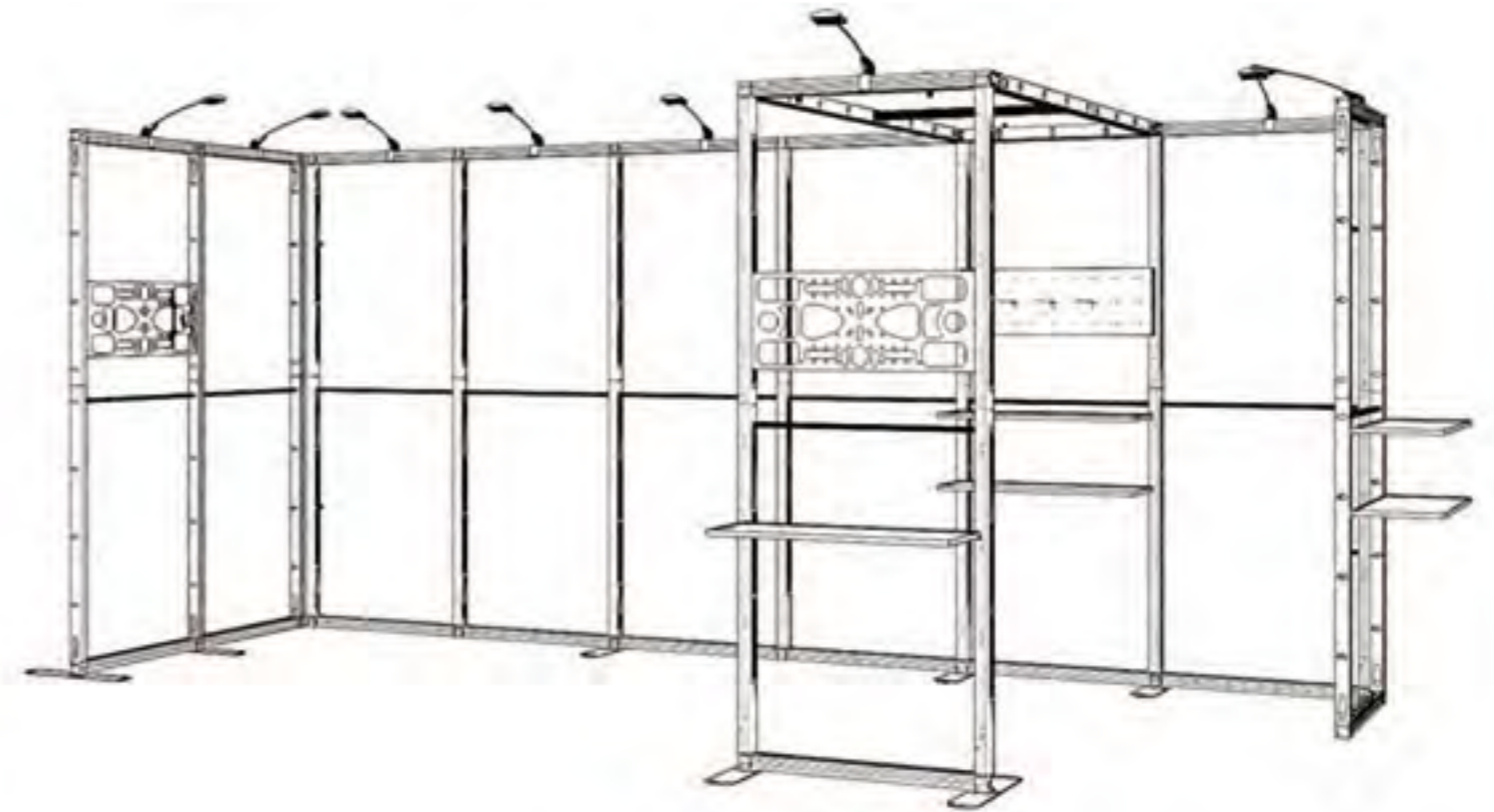

Luban kit 6m/20'
NO.002

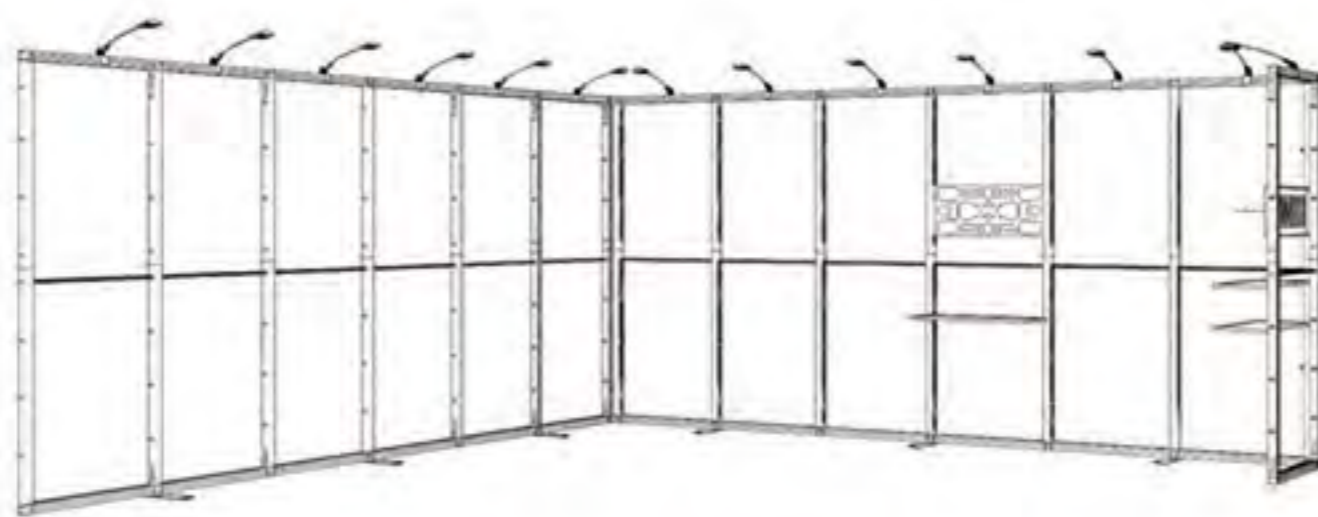

Luban kit 6m/20'
NO.003



Luban kit 6m/20'
NO.004

Beispiele 6m

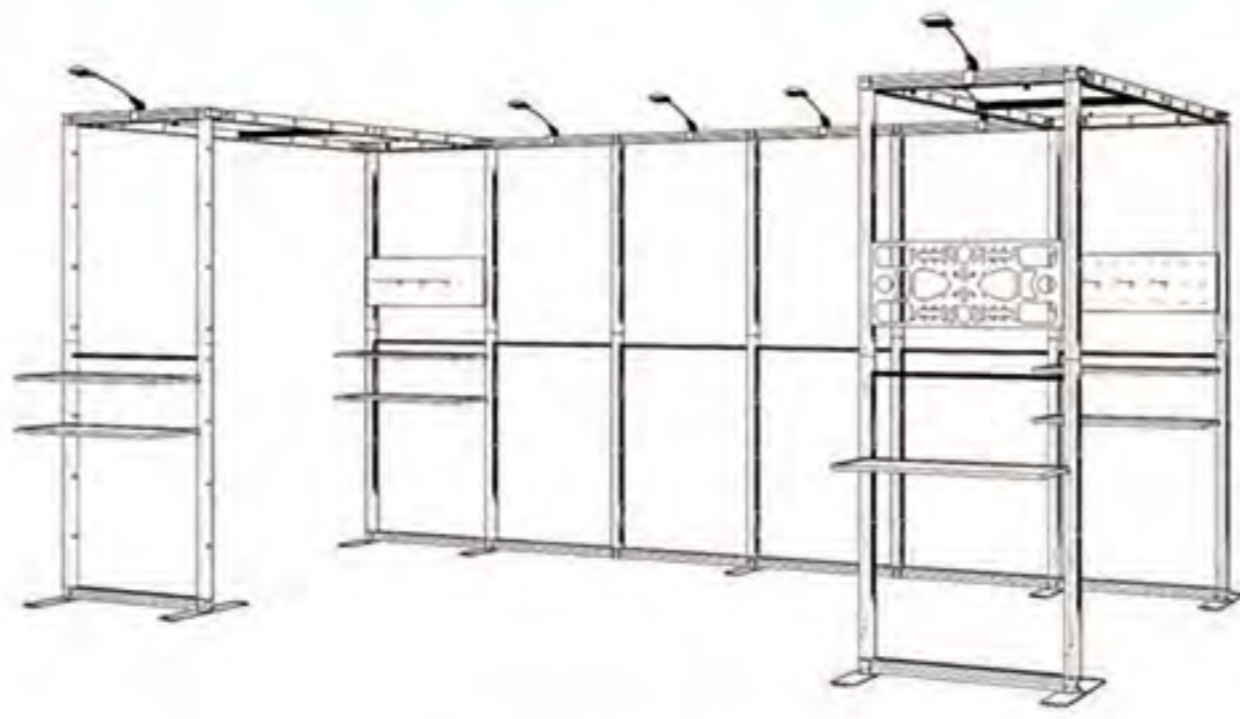

Luban kit 6m/20'
NO.005

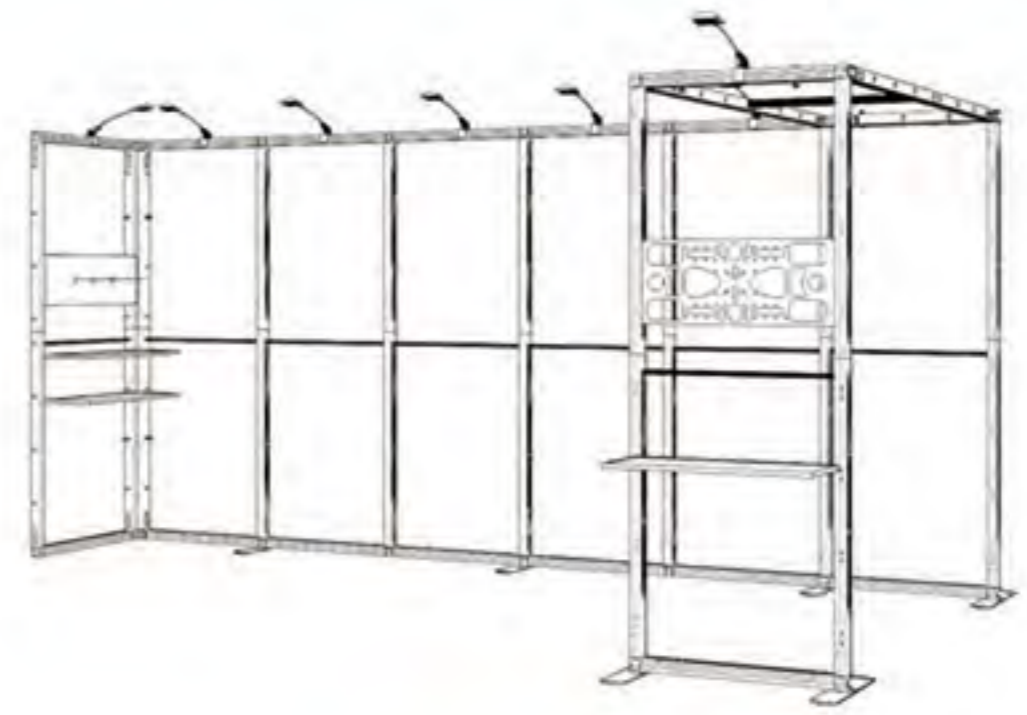

Luban kit 6m/20'
NO.006

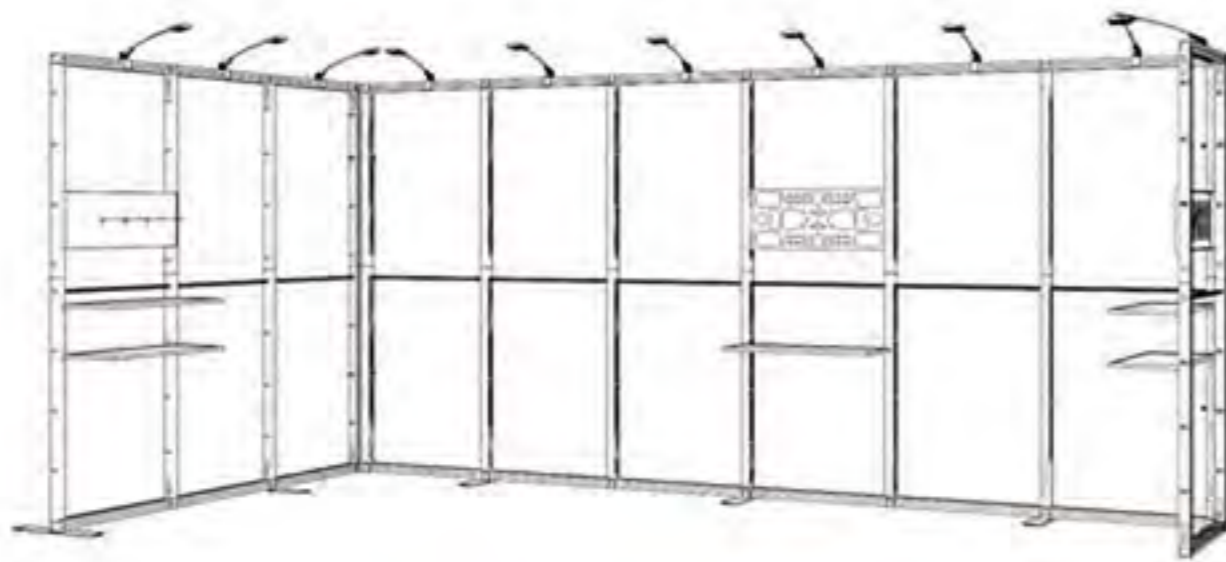

Luban kit 6m/20'
NO.007

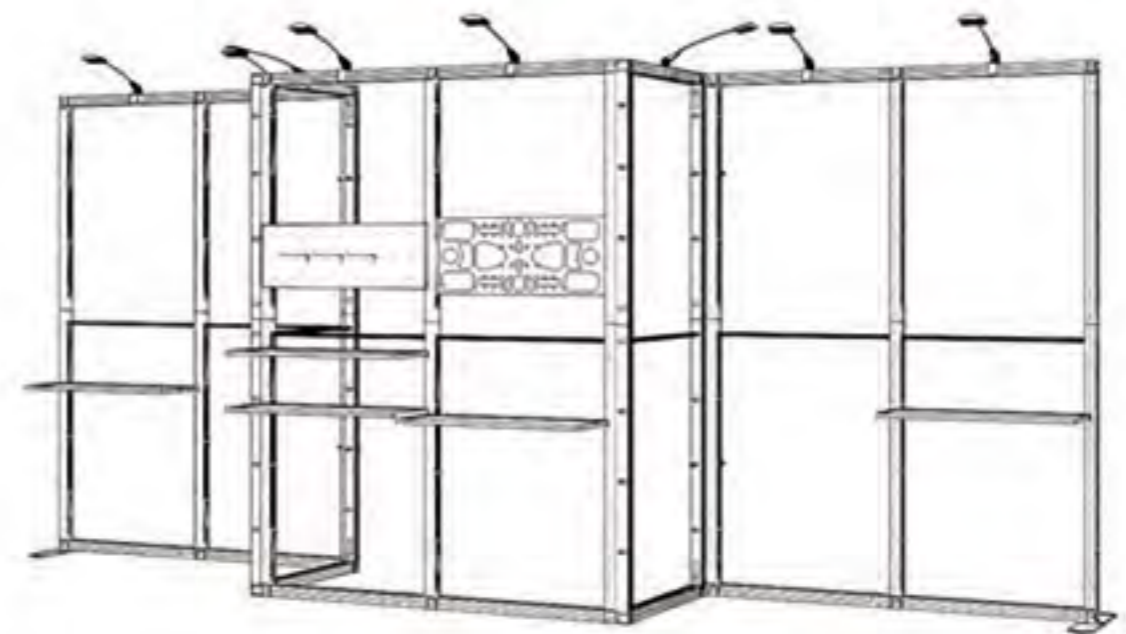

Luban kit 6m/20'
NO.008



Luban kit 6m/20'
NO.009



Luban kit 6m/20'
NO.010



Luban kit 6m/20'
NO.011



Luban kit 6m/20'
NO.012

Beispiele 3m

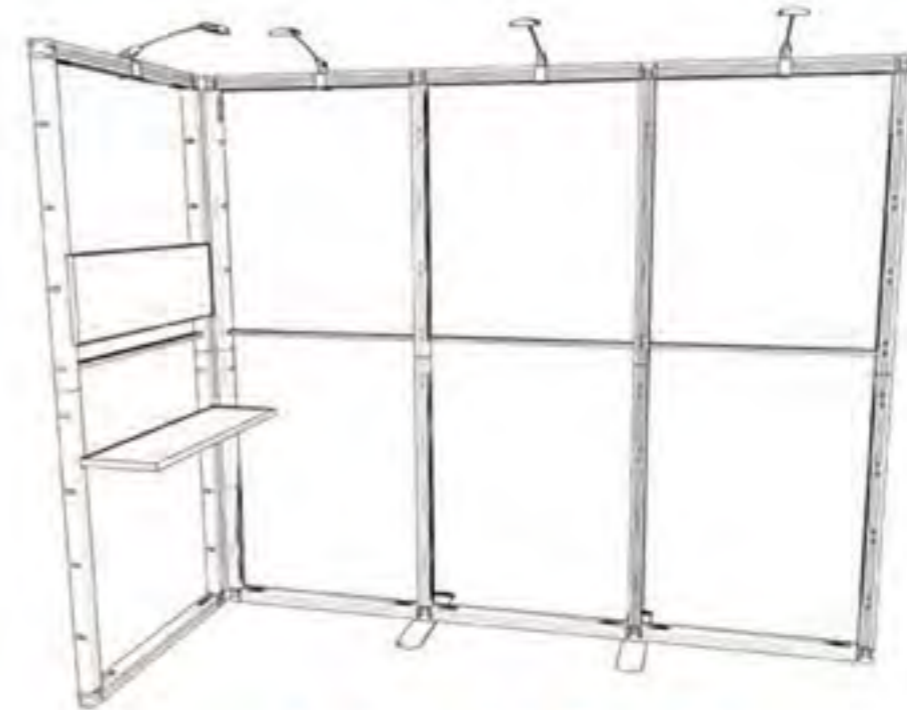

Luban kit 3m/10'
NO.001

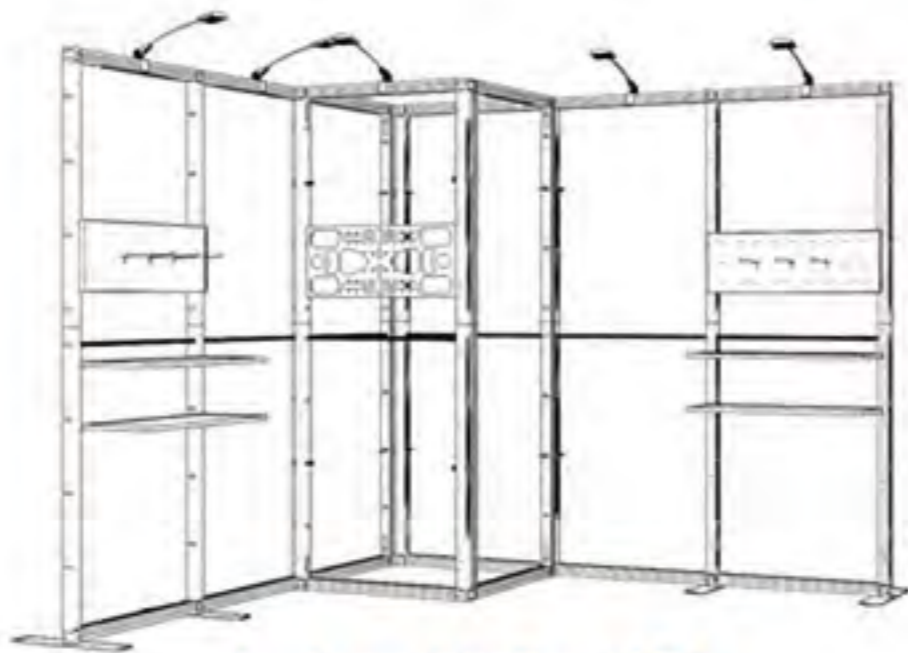

Luban kit 3m/10'
NO.002



Luban kit 3m/10'
NO.003

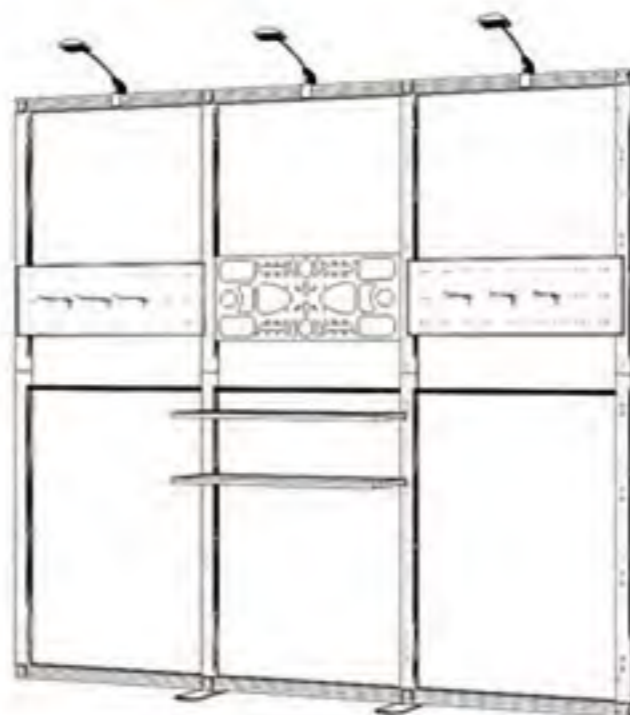

Luban kit 3m/10'
NO.004

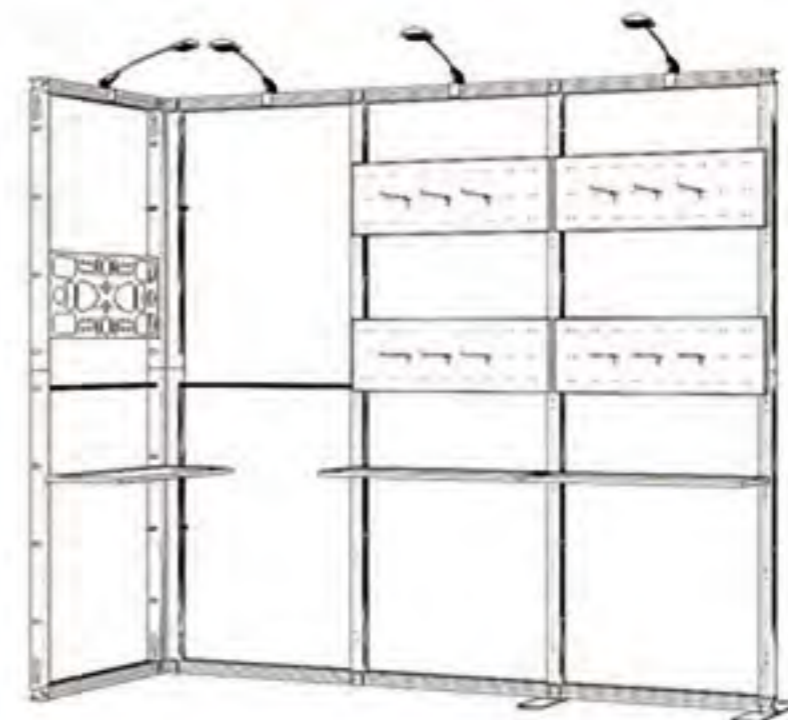

Luban kit 3m/10'
NO.005

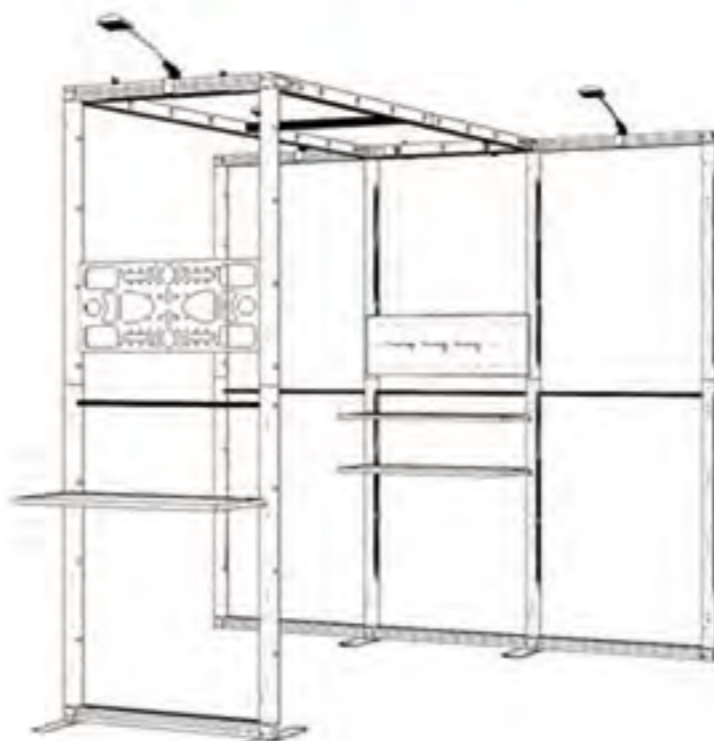

Luban kit 3m/10'
NO.006

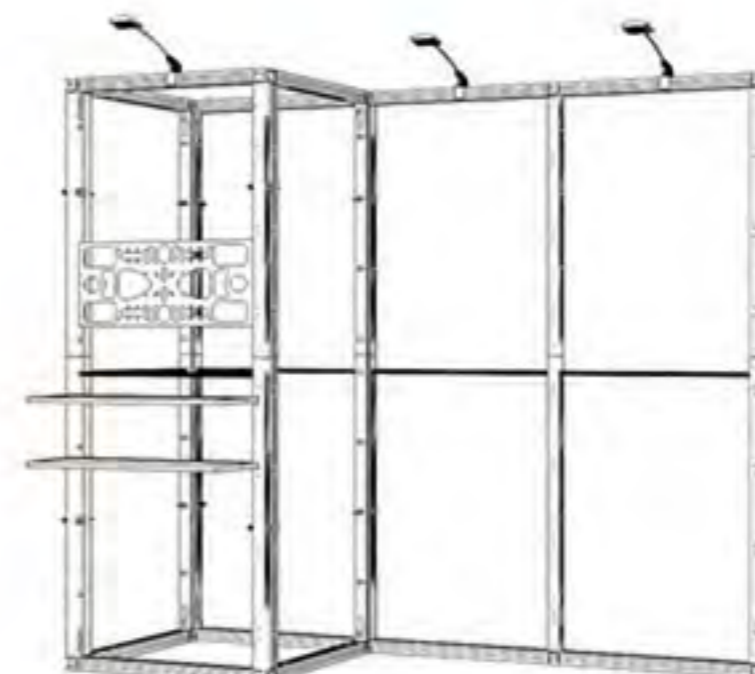

Luban kit 3m/10'
NO.007

Beispiele 3m

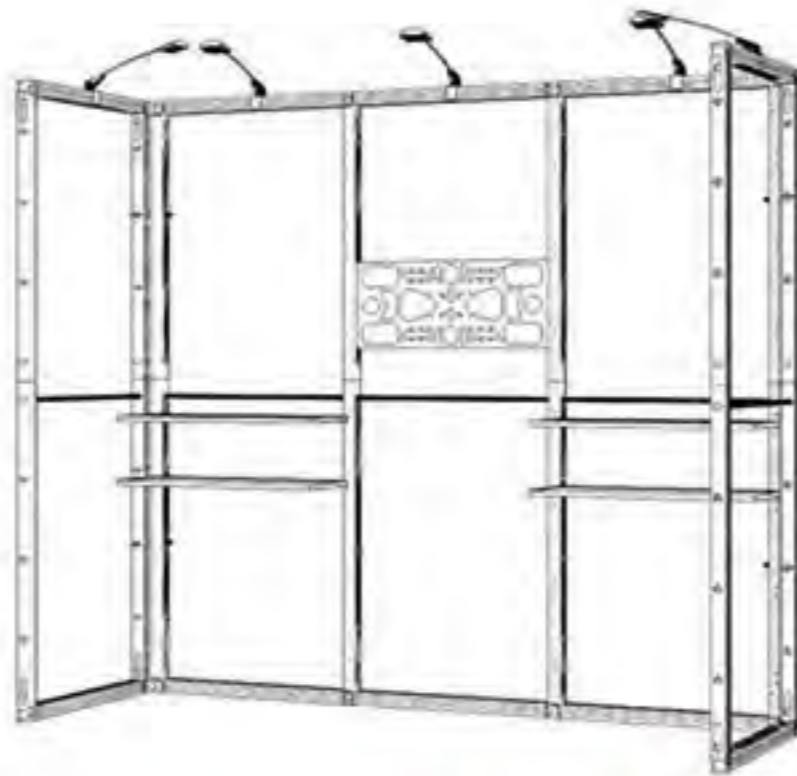

Luban kit 3m/10'
NO.008

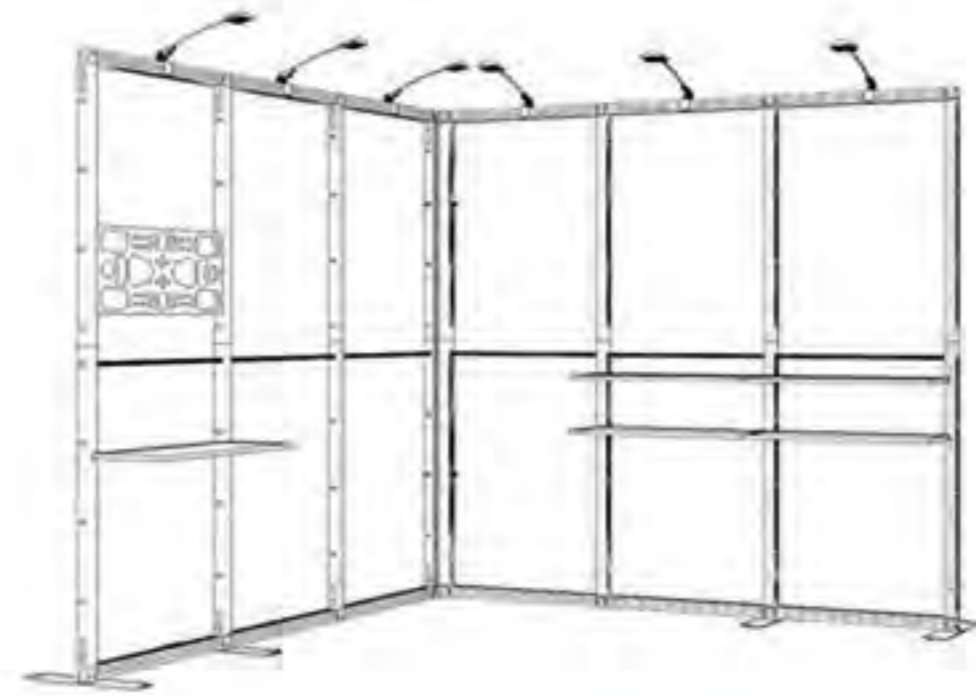

Luban kit 3m/10'
NO.009

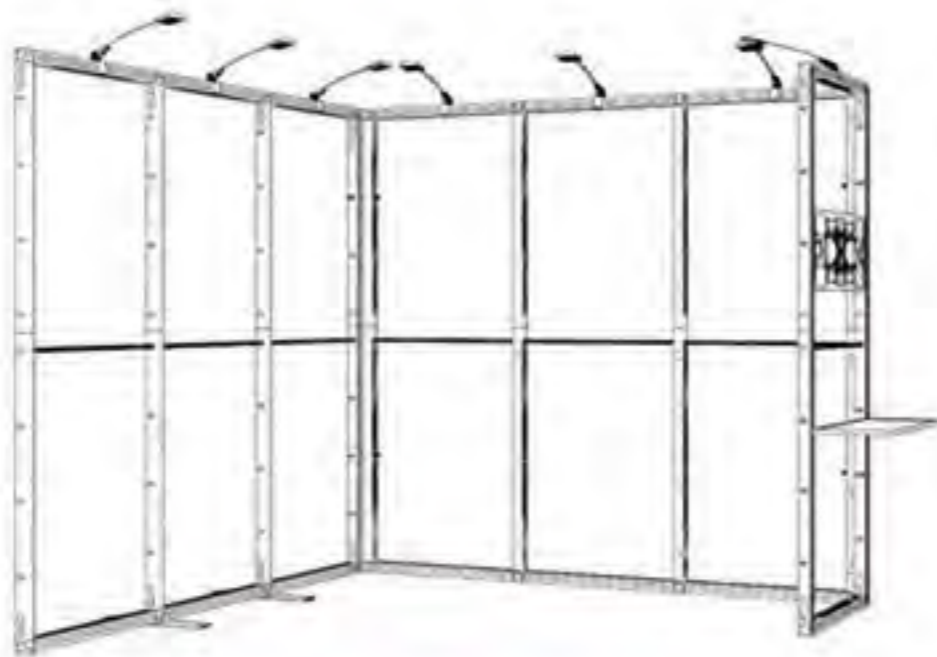

Luban kit 3m/10'
NO.010



Luban kit 3m/10'
NO.011

Es lassen sich mit Luban z.B. Kabinen, Brücken und Theken bauen, die Wände auf bis zu 4m erhöhen und Regale, Displays und Monitore befestigen.

Aufgrund der Einfachheit und Schnelligkeit mit der die Aluminiumrahmen zusammengebaut werden, lassen sich innerhalb sehr kurzer Zeit attraktive Stände als Rundumlösung für Shops, Events und Messen errichten.