

Introducing your **innovative**
and **cost-effective** modular
Display Solution.





FASTFRAME™ is a unique, **sustainable** and **user-friendly** Display Solution, only from Ultima Displays.



More versatile than a pop-up

- » Highly configurable
- » Seamless graphics
- » Easy to change Silicone Edge Graphics (SEG)
- » Many applications



More flexible than a roller banner

- » Assembled in seconds
- » Lightweight, highly portable
- » One frame, multiple graphics
- » Single or double sided graphics
- » Expandable, no joints
- » Washable stretch fabric
- » Cost savings through repeated use



More configurable than an exhibition stand

- » Expandable – add modules over time
- » Quick change design
- » Excellent space utilisation
- » Toolless construction
- » Seamless graphic overlay

Transform your space in seconds using **FASTFRAME™**



1. Folded state

The lightweight frame is pre-assembled in a convenient, portable carry bag.



2. Unfold

From its pre-assembled state, the frame can then be effortlessly unfolded and locked in place with a central support rod.



3. Components

Feet can be added if required to add additional rigidity to the frame.



4. Install graphics

Your graphics, available in a Standard or Premium finish, can then be applied to the fully assembled frame.

Sustainable exhibitions

With sustainability a key theme for event organisers and exhibitors alike, modular exhibition systems offer an environmentally conscious choice.

- » Made from aluminium, an infinitely recyclable material
- » Using polyester graphic materials which can be recycled multiple times
- » Graphics printed using water based inks
- » One system for multiple display applications



Enjoy **many benefits**, such as:



An efficient toolless frame

Unit can be constructed and ready in a short amount of time.



Lightweight and ultra slim

Unit is highly portable, making travel and storage much easier.



Seamless graphic

Apply a single graphic to connected frames to create a large seamless display.



Sustainable

Multiple use, not single use.



Interchangeable graphics

Display multiple messages time and time again.



FASTFRAME™ utilises **Silicone Edge Graphics**

- » Fabric graphics are edged with a silicone strip which slots into the channel of the frame for easy installation
- » This is more cost-effective than alternative options and can be used multiple times
- » The graphics are printed using water based inks which is more eco-friendly
- » Seamless graphics can be applied to the connected frames for large displays
- » Graphics can be reproduced to deliver new messages



Assemble **countless configurations**

One system, endless applications for all spaces.

- » Product launches
- » Pop-up display
- » Mid-size exhibition
- » Conferences
- » Recruitment fair
- » Reception display

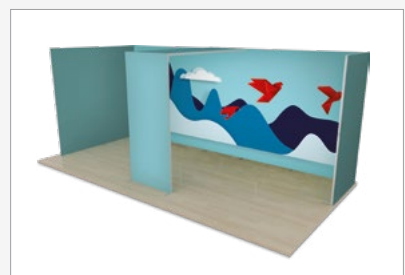
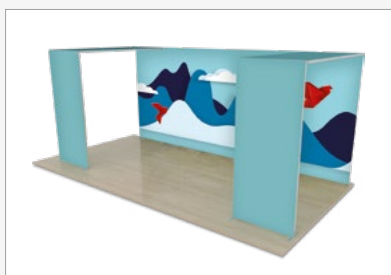
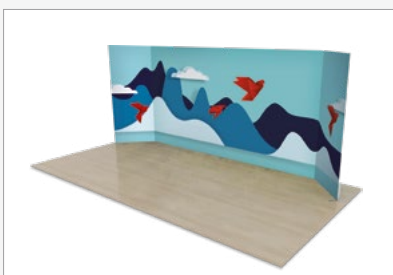
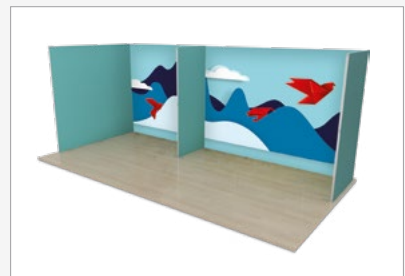
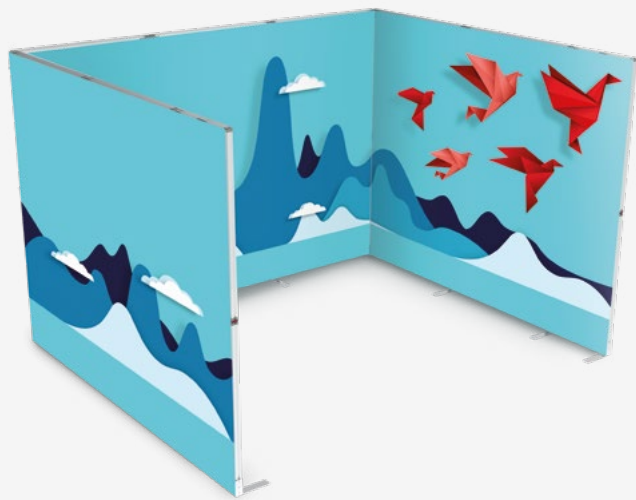

Use **different connectors**

Enabling you to create an infinite amount of configurations.

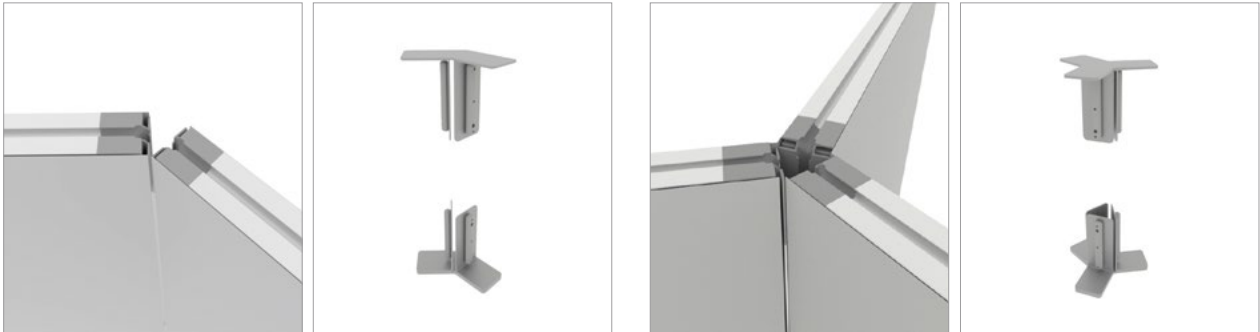

A **range of sizes** available

FASTFRAME™ is available in 5 sizes, all with a slimline 40mm frame profile.

- » 1000 x 500mm
- » 1000 x 1000mm
- » 1000 x 2000mm
- » 1000 x 2400mm
- » 1200 x 2400mm

